

Monkey track - blue

Product type OPD-8301KB-10

Basic information

Age category	2 - 10 years
Minimum area	8,24 m x 5,66 m
Equipment measurements	5,24 m x 2,66 m x 1,3 m
Free fall height:	1 m
Max. number of users:	9
Fall zone: EN 1177	Grass surface
Certificate of Compliance:	ČSN EN 1176-1 ed.2 +A1:2024 ČSN EN 1176-11:2015

Material

Metal units - structural steel
Ropes and nets - polypropylene with a steel internal core
Plastic units - polyamide

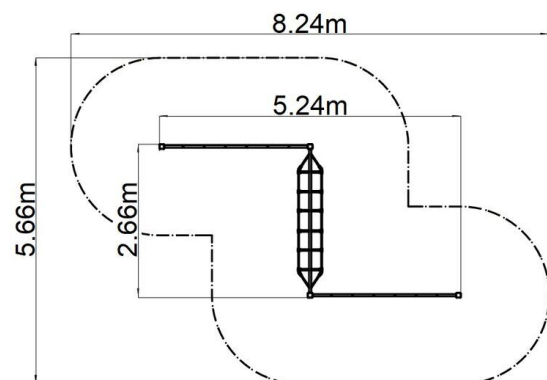

Finish

Duplex powder coated with coat curing
Hot-dip galvanizing

Description

The supporting structure is made of galvanized structural steel and then powder coated, and all other metal parts are made of black structural steel, sandblasted, duplex sprayed with powder coated. The ropes are made using HERKULES material (16 mm thick ropes made from polypropylene with a steel internal core) and are connected with plastic joints. All fastening material is galvanized or stainless steel.

Equipment

We offer four color variants of the support structure - red, blue, brown and lime.